



/ Model A1

Overall size: Height: 50-500 cm / 20 in-16 ft

Glass element size: Width: 19-40 cm / 7-16 in
Diameter: 16-35 cm / 6-14 in

Materials: Blowing glass, brass, aluminum, stainless steel

Light source: EU: LED E27 | 220-240V
USA: LED E26 | 100-127V

/ Material

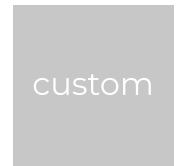

Brushed aluminum

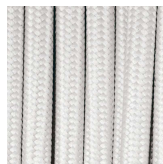

White wire

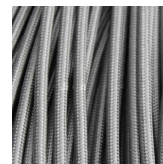

Silver wire

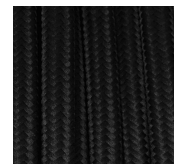

Black wire

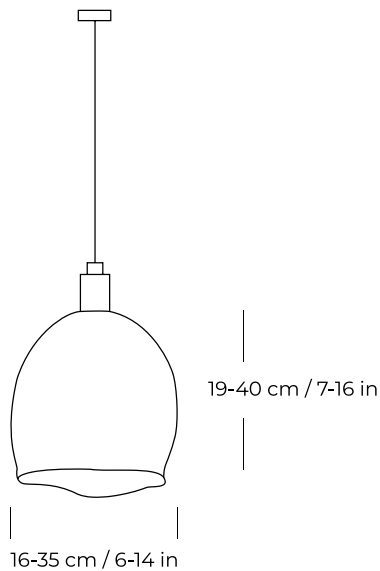

All items are handmade by the best craftsmen. We implement the boldest non-standard projects, which result in a one-of-a-kind product. We eliminated mechanical processes in production as much as possible, thanks to manual work there are never two exact pieces. Each work made is a unique work of art.



/ Model A1/3

Overall size: Height: 50-500 cm / 20 in-16 ft

Glass element size: Width: 19-40 cm / 7-16 in
Diameter: 16-35 cm / 6-14 in

Materials: Blowing glass, brass, aluminum, stainless steel

Light source: EU: LED E27 | 220-240V
USA: LED E26 | 100-127V

/ Material

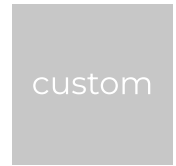

Brushed aluminum

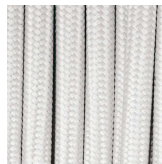

White wire

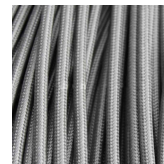

Silver wire

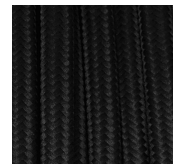

Black wire

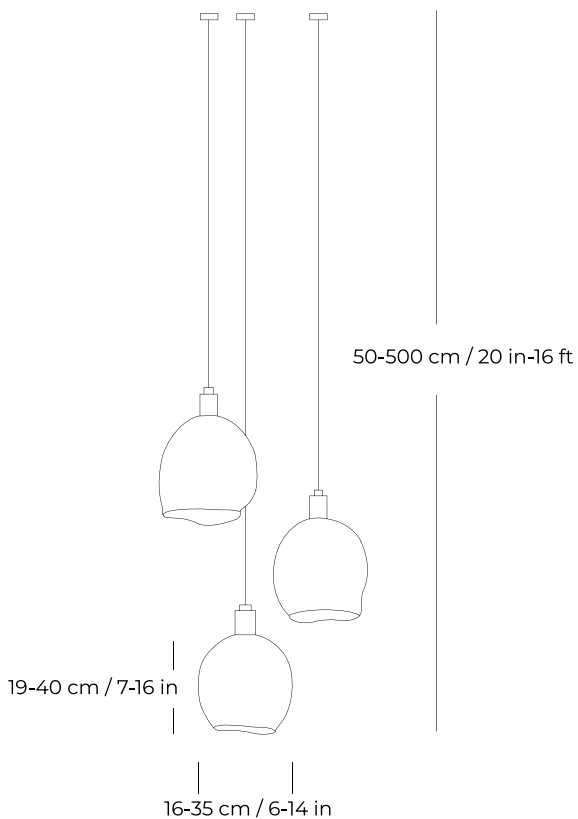

All items are handmade by the best craftsmen. We implement the boldest non-standard projects, which result in a one-of-a-kind product. We eliminated mechanical processes in production as much as possible, thanks to manual work there are never two exact pieces. Each work made is a unique work of art.



/ Model A1/12

Overall size:	Height: 50-500 cm / 20 in-16 ft Width: 16-500 cm / 6 in-16 ft
Glass element size:	Width: 19-40 cm / 7-16 in Diameter: 16-35 cm / 6-14 in
Materials:	Blowing glass, brass, aluminum, stainless steel
Light source:	EU: LED E27 220-240V USA: LED E26 100-127V

/ Material



Clear glass



Brushed aluminum



custom

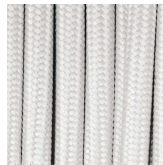

White wire

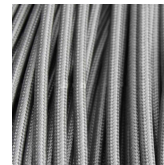

Silver wire



Black wire

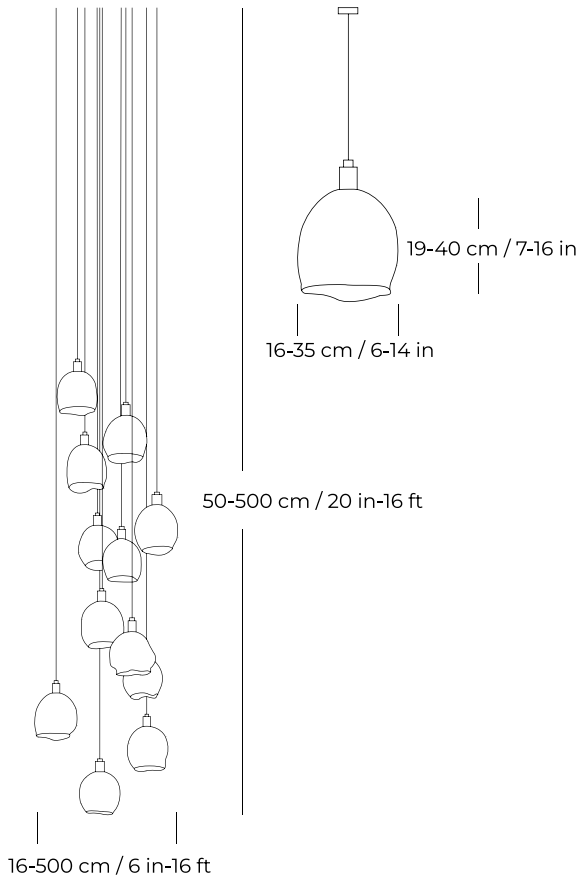

All items are handmade by the best craftsmen. We implement the boldest non-standard projects, which result in a one-of-a-kind product. We eliminated mechanical processes in production as much as possible, thanks to manual work there are never two exact pieces. Each work made is a unique work of art.